

FTCT-74ET FTCT-78ET

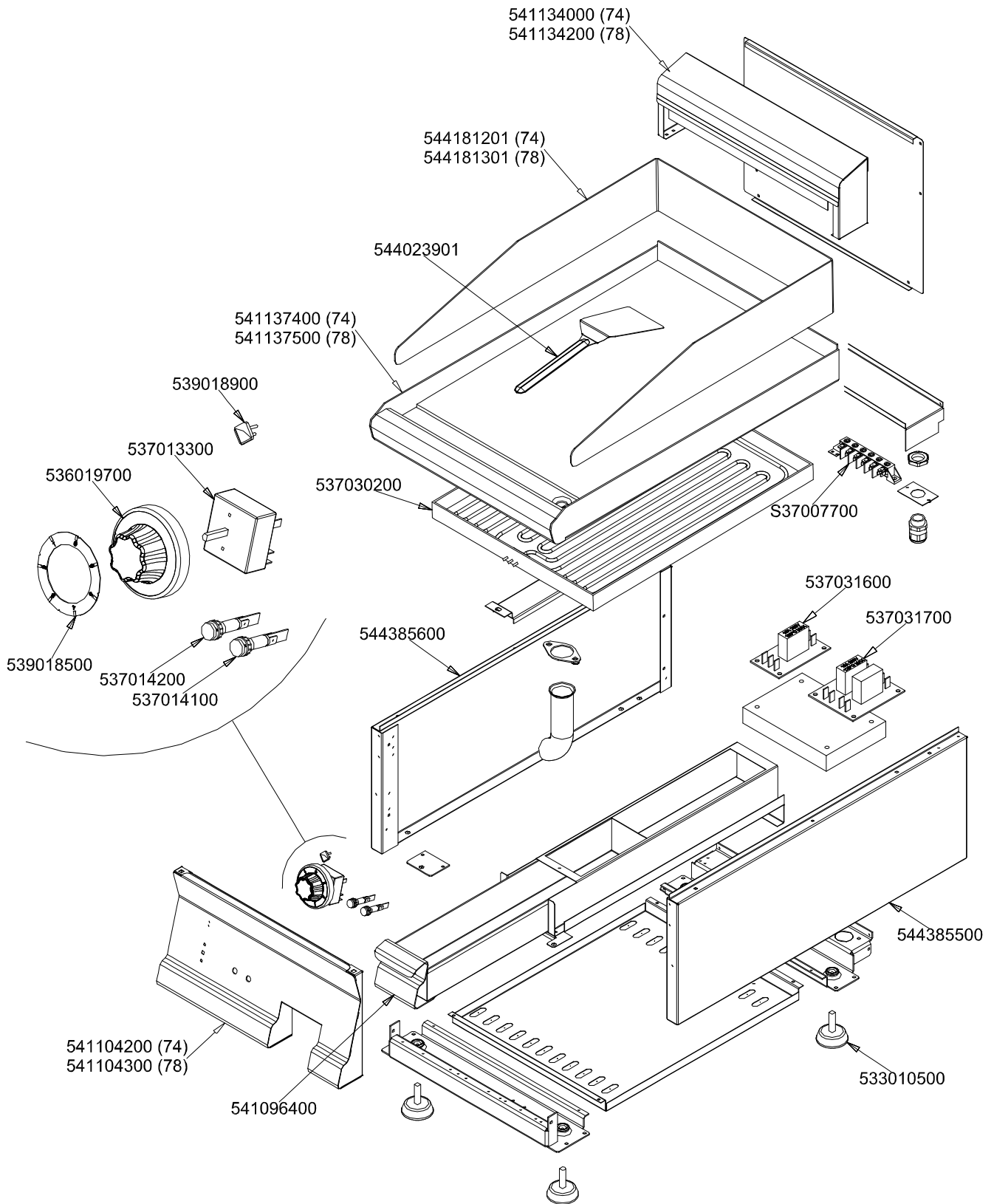

560040700M00P00

Page	Pos	Code	Description
001		541134200	NEUTRAL LOW SPACER 78
001		544181301	SPLASH GUARD FT-78
001		544023901	SPATTLE FOR FRY-TOP
001		541137500	UPPER PLATE FTC-78E WITH GLASS
001		539018900	INDEX FOR KNOB
001		537013300	CURRENT REGULATOR FOR ELEC. PLATE
001		536019700	BLACK KNOB §70 PIN §6*5
001		537030200	EL. PLATE 363X485 2700W230V
001		539018500	ADHESIVE GRADUATED DISC FOR KNOB
001		537014200	GREEN WARNING LIGHT 250V
001		537014100	WHITE WARNING LIGHT 250V
001		544385600	LEFT SIDE OF 70T LINE
001		S37007700	
001		537031600	ELECTRO BOARD 1 RELAI
001		537031700	ELECTRO BOARD 2 RELAI
001		544385500	RIGHT SIDE OF 70T LINE
001		533010500	LEG M10*25 D.40
001		541096400	DRIP TRAY FT S.70
001		541104300	CONTROL PANEL FT-78E