

FO-1G FO-2G FO-3G

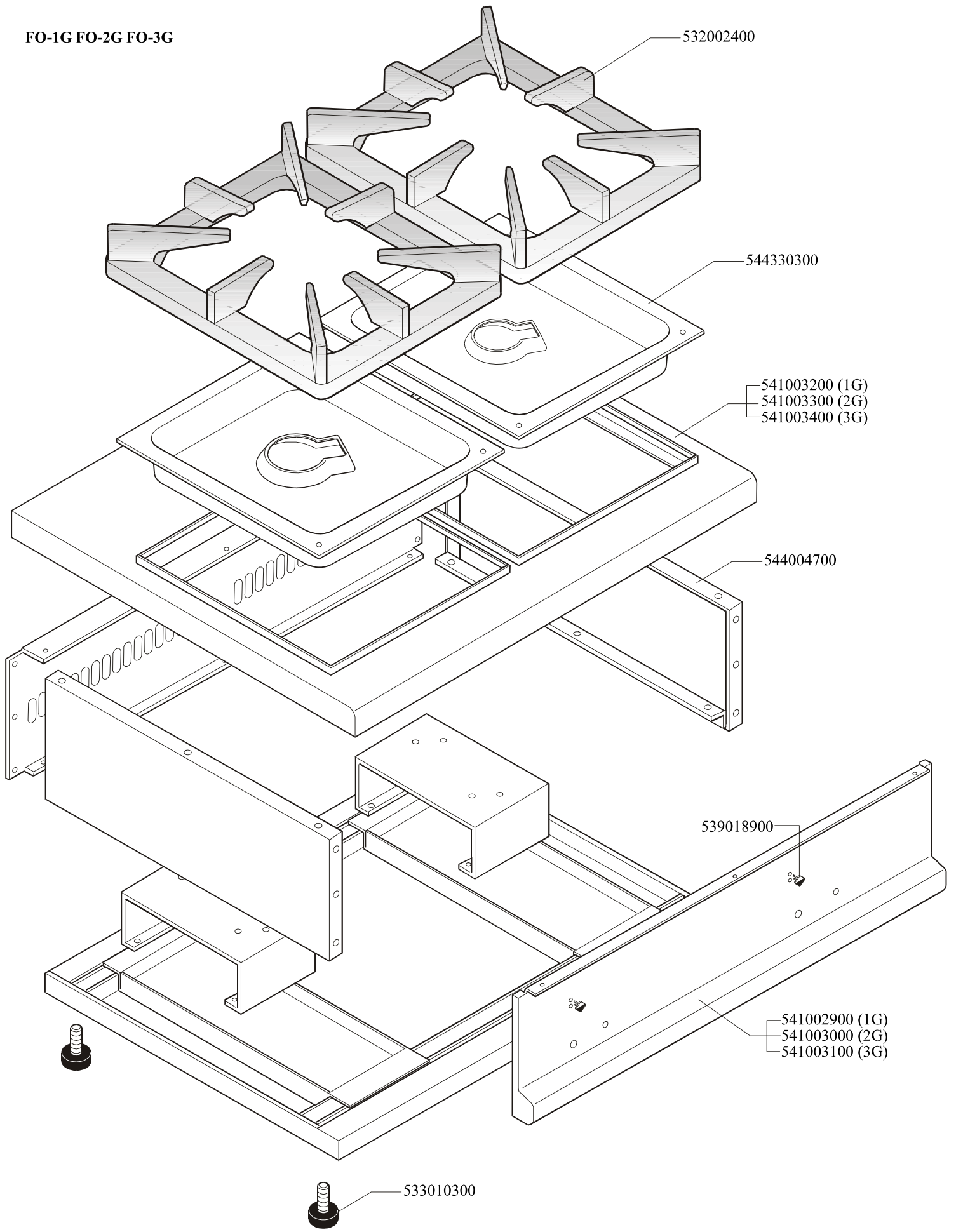

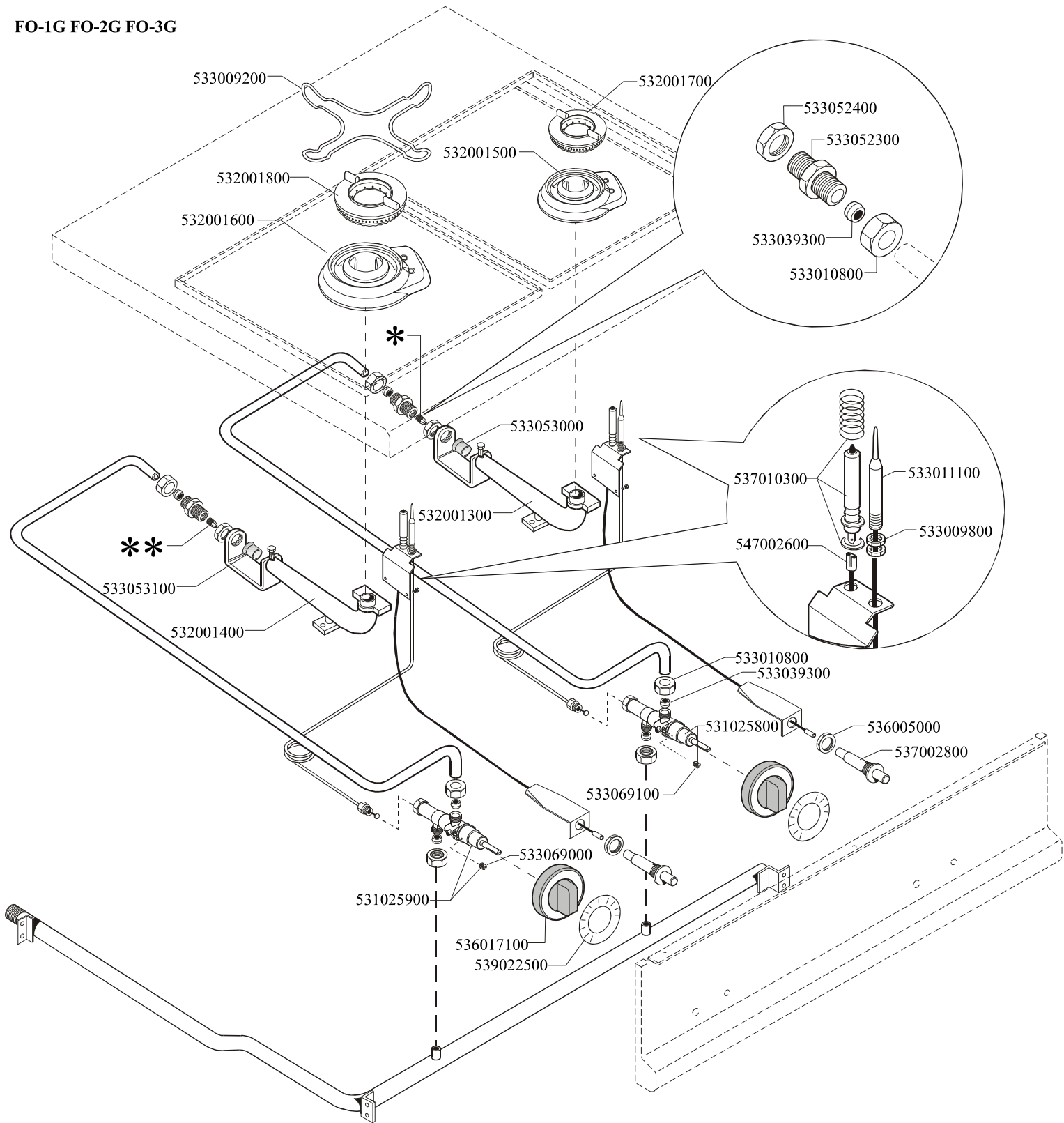

	*	**
G30- 28+30mbar G31- 37mbar	533015400	533043400
G30- 50mbar	533015300	533043300
G20- 20mbar G25- 25mbar	533015200	533019400
G25- 20mbar	533030300	533043600
G25- 25mbar NL	533014900	533043500

Page	Pos	Code	Description
001		532002400	1 FLAME GRILL 372X346 (FO)
001		544330300	ANAMELLED BURNER DRIP TRAY 2/3
001		541003300	UPPER PLATE FO-2G
001		544004700	SIDE OF FO
001		539018900	INDEX FOR KNOB
001		541003000	CONTROL PANEL FO-2G
001		533010300	ADJUSTABLE FOOT M10*20 D.23
002		533009200	REDUCTION FOR 65 AND 70 LINE
002		532001800	QUICKBURNER §102
002		532001600	BURNER BODY 5,5 KW
002		532001500	BURNER BODY 3,5 KW
002		532001700	QUICKBURNER §82
002		533052400	NUT M20*1 H4
002		533052300	JOINT FOR NOZZLE HOLDER
002		533039300	BICONE §10
002		533010800	TUBE NUT D.10 M16*1,5
002		533053000	AIR ADJUSTMENT BUSHING §18
002		532001300	BURNER VENTURI 3,5 KW
002		533053100	AIR ADJUSTMENT BUSHING §20
002		532001400	BURNER VENTURI 5,5 KW
002		537010300	PLUG IGNITION WITH SPRING PC65
002		533011100	THERMOCOUPLE 600 M8*1
002		533009800	BRASS NUT M8*1
002		547002600	HIGH-VOLTAGE CABLE L=500
002		536005000	NUT M18 FOR PIEZOELECTRIC IGNITION
002		537002800	PIEZOELECTRIC IGNITION M18
002		531025800	SAFETY TAP 20S-B PEL20S2160
002		533069100	BY PASS COCK §60 20S
002		533069000	BY PASS COCK §70 20S-21S
002		531025900	SAFETY TAP 20S-B PEL20S21070
002		536017100	BLACK KNOB §70 PIN §8*6,5
002		539022500	ADHESIVE GRADUATED DISC FOR KNOB
002		533015400	NOZZLE §93 CH12*14 G-PC4 R
002		533043400	NOZZLE §117 CH12*14 G-PC4 UR
002		533015300	NOZZLE §82 CH12*14 F-PC4 R
002		533043300	NOZZLE §103 CH12*14 F-PC4 UR
002		533015200	NOZZLE §145 CH12*14 F-FP/CP6
002		533019400	NOZZLE §180 CH12*14 L-FQ5
002		533030300	NOZZLE §160 CH12*14 M-FPG
002		533043600	NOZZLE §200 CH12*14 L-PC4 UR
002		533014900	NOZZLE §150 CH12*14 F-FQ5 L-FQ6
002		533043500	NOZZLE §190 CH12*14 G25 PC4R