

KROMO

TABLE

KI4310

REV

01

GLASSWASHER K 45

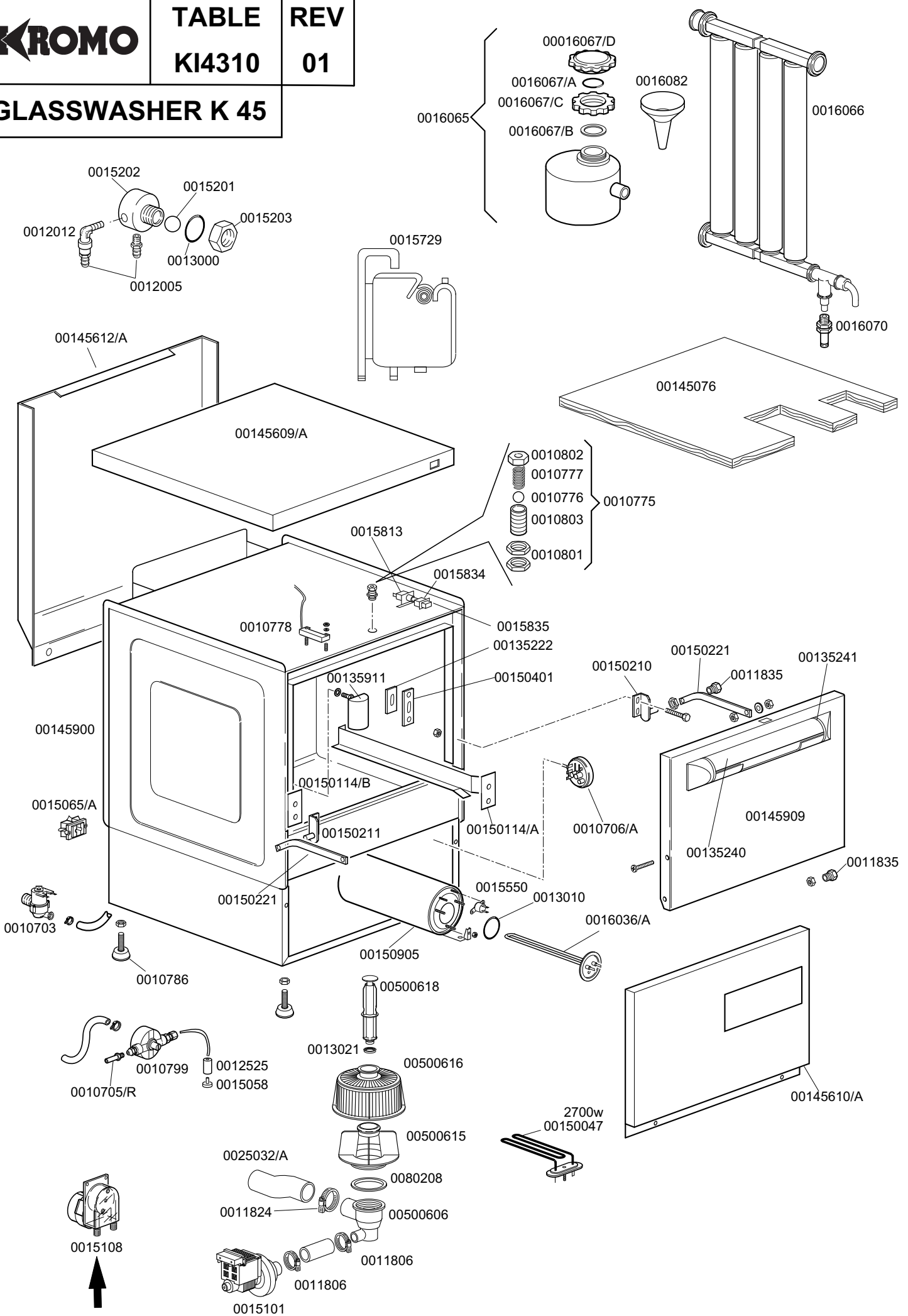

GLASSWASHER K 45

**TABLE
KI4310**

CODE	DESCRIPTION	CODE	DESCRIPTION
0010703	220V entry solenoid valve	0016070	CFD complete non-return valve
0010705/R	D.8 pipe fitting	0016082	Funnel
0010706/A	"EL" pressure switch	0025032/A	Coupling for suction K50
0010775	Brass door hook	00500606	Right floor drain grey
0010776	9.52 diam. stainless steel ball	00500615	Ferrule with filter - grey
0010777	Spring for door hook	00500616	Filter for suction
0010778	Reed magnetic microswitch	00500618	Overflow device
0010786	40 d. M10x25 small black foot	0080208	Ramp seal 95x75x3
0010799	Shining product dosing device	0016067/D	Salt container plug
0010801	Door jack nut		
0010802	Door jack locknut		
0010803	Door jack body		
0011806	25/40 stainless steel clamps		
0011824	50/70 clamps		
0011835	Brass bush		
0012005	1/4 rubber holder for 10 d. pipe		
0012012	Elbow pipe fitting 1/4 brass		
0012525	Counter-weight for small filter		
0013000	OR 3125 gasket		
0013010	OR heating element gasket		
0013021	DEM 40 gasket		
00135222	Beating door		
00135240	Handle door in plastic		
00135241	Ending of handle K		
00135911	Complete air trap		
00145076	Polystyrene coat K 45		
00145609/A	Lid for K 45		
00145610/A	Lower door K 45		
00145612/A	Dorsal panel K 45		
00145900	Complete body K 45		
00145909	Complete door K 45		
00150047	Tube el. resistance 2,7kw 230v		
00150114/A	Right guide for basket		
00150114/B	Left guide for basket		
00150210	Right hinge door		
00150211	Left hinge door		
00150221	Door rod		
00150401	Guide for bent rod		
0015058	Small shining product suction filter		
0015065/A	Cable fastener with screw		
00150905	Boiler mod. 50		
0015101	220-240v drain pump		
0015108	G15 electrical dosing device		
0015201	17d. teflon DVGW safety valve sphere		
0015202	40x33 d. DVGW brass pipe fitting		
0015203	30 DVGW brass nut for pipe fitting		
0015550	Conveyor safety thermostat		
0015729	2,5 lt. break tank		
0015813	16A unipolar switch electric component		
0015834	Start switch		
0015835	Square start push button		
0016036/A	230V 2,5 kw heating element		
0016065	Salt container		
0016067/A	OR for salt container plug		
0016067/B	Salt container gasket		
0016067/C	Salt container ferrule		

KROMO

**TABLE
KI4330**

**REV
01**

DISHWASHER K 45

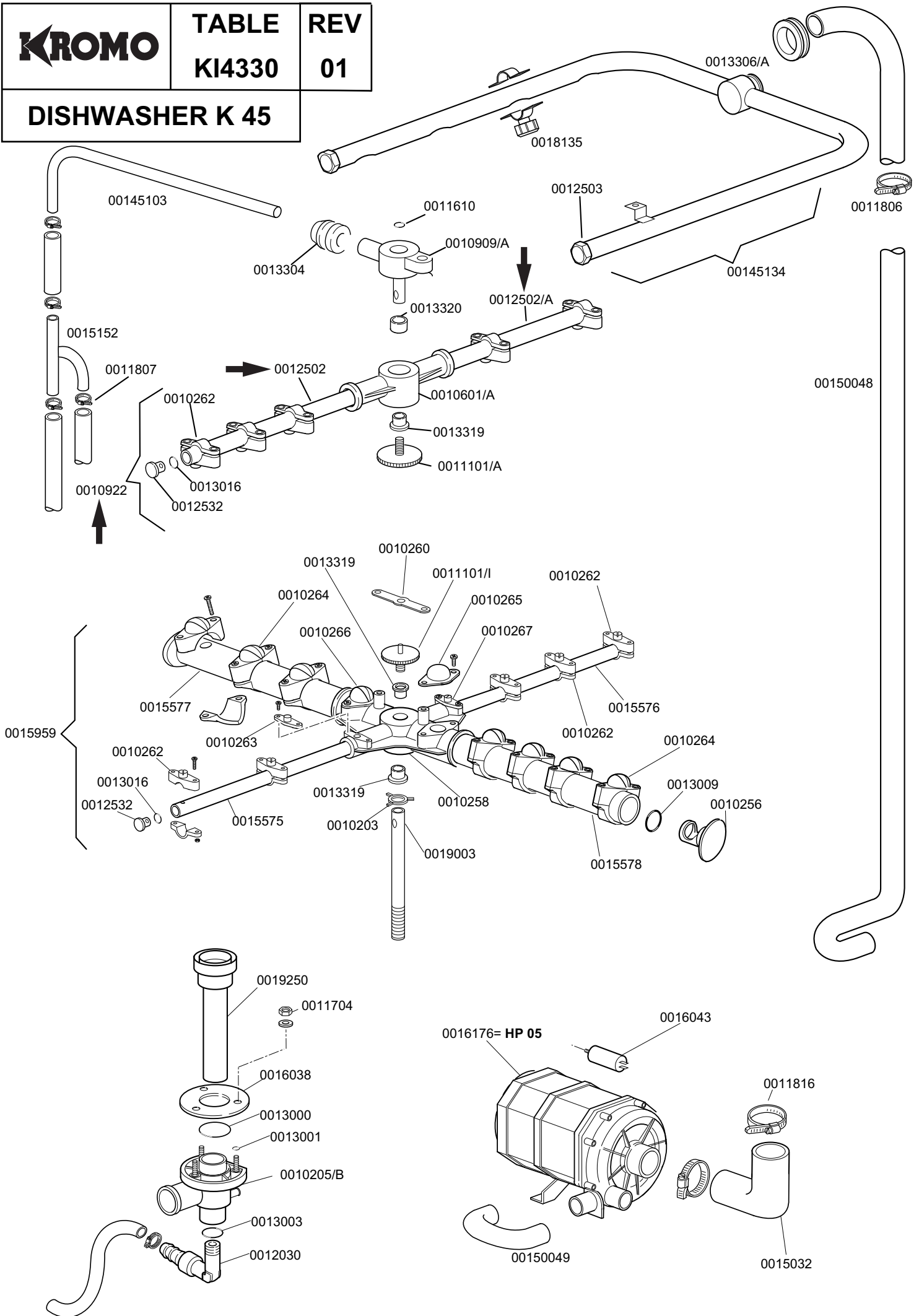

KROMO	TABLE	REV
	KI4461	00
DISHWASHER K 45-50-80		

REGENERATION / DRAIN PUMP VERSION

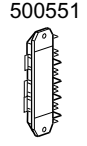
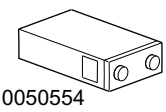
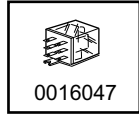

0010708/B
0010708/T
0010708/L

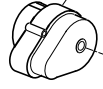

0016037= 230V
0015620=220/240V



0050557

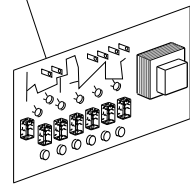

0050559

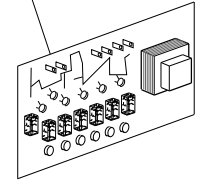

0050562

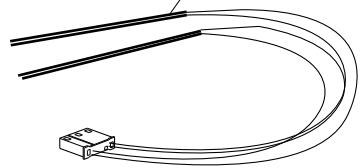

0010707/1

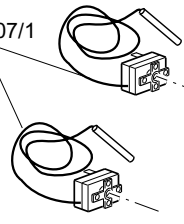

00150309/A

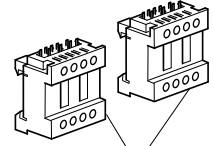
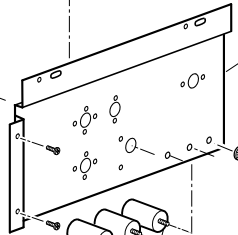

0015086= 230V 50/60Hz
0015086/B= 240V 50Hz

0015149

00150111-K50
00150121-K80

00135606/A(Gray)
00135603/A
00135616

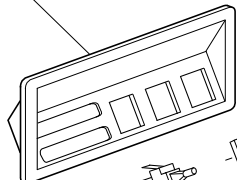

0015812 0015824 0015874

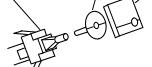

0015825

0015826

0015870
0015854



0015811/A
0015813

0015880

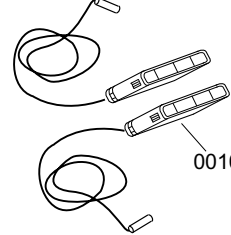

001050011

STANDARD CONTROL PANEL K-45/50/80

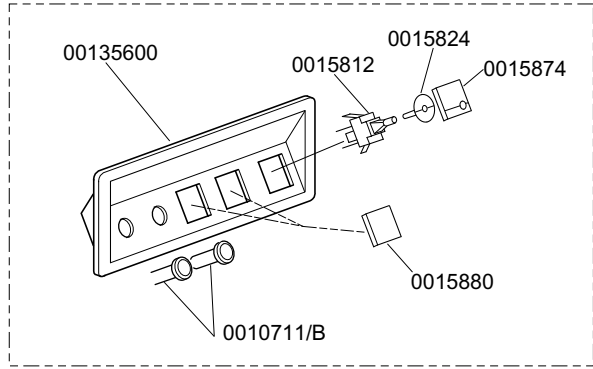

0015812 0015824 0015874

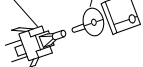

0015880

0015854 0015858

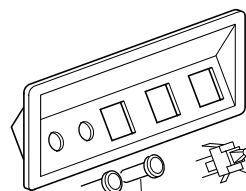

0015813

0010711/B

00135600

0015813