

541134000 (74)
541134200 (78)
541134800 (712)

1

537027400

544173500

541103900 (74)
541104000 (78)
541104100 (712)

544173400

536005200

531015900 (X)

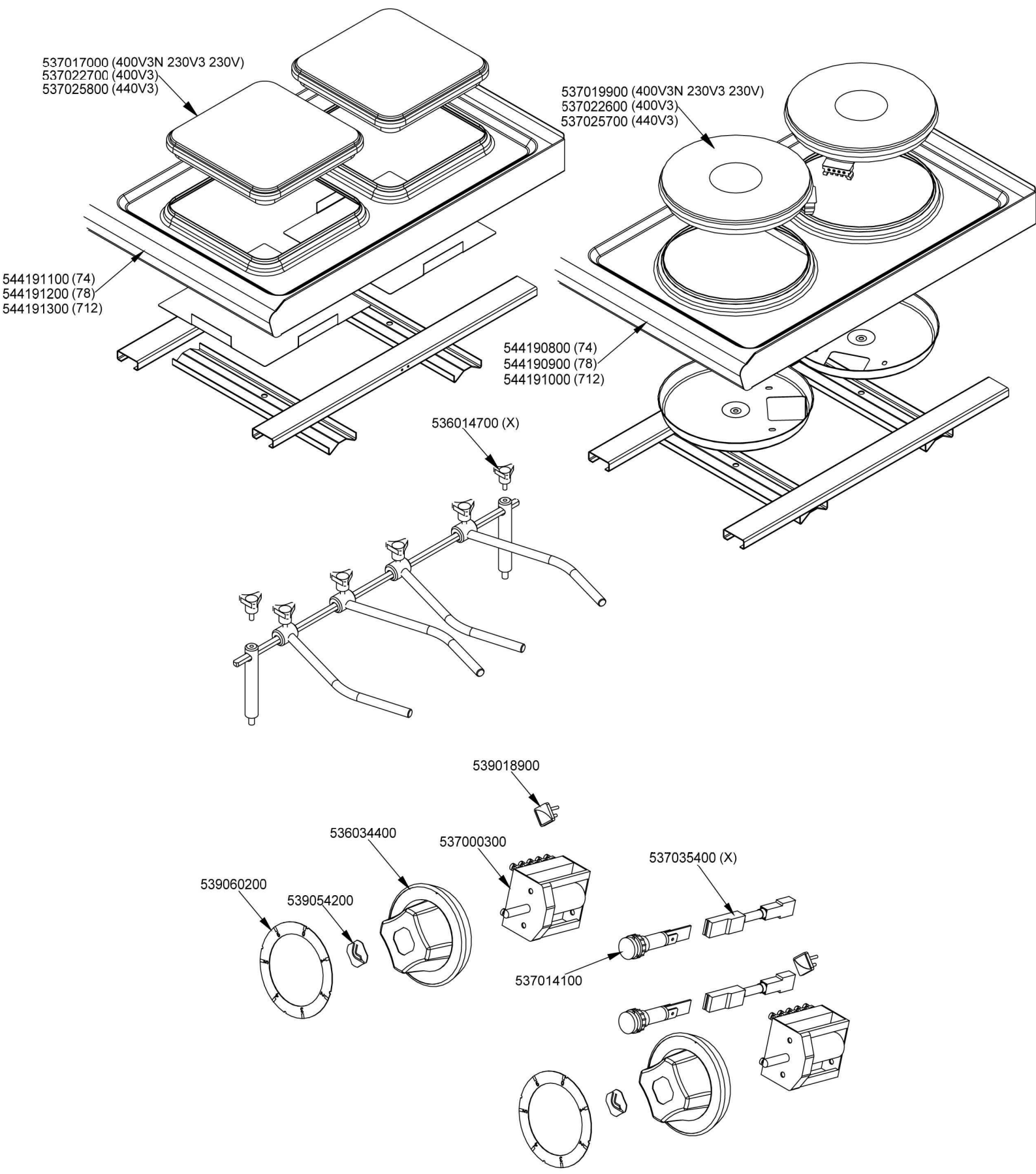

Page	Pos	Code	Description
001		541134000	NEUTRAL LOW SPACER 74
001		537027400	TERMINAL BLOCK THREEPHASE 40A
001		544173500	LEFT SIDE PANEL S.70
001		541103900	CONTROL PANEL PC-74E
001		544173400	RIGHT SIDE PANEL S.70
001		536005200	INOX LEG 2" 120-180 M10
001		531015900	ADJUSTABLE LEG 2"
002		537017000	PLATE 220X220 W2600 V230
002		537022700	ELECTRICAL PLATE 220X220 W2600 V400
002		537025800	PLATE 220X220 W2600 V440
002		537019900	PLATE D.220 W2600 V230
002		537022600	ELECTRICAL PLATE D.220 W2600 V400
002		537025700	ELECTRICAL PLATE D.220 W2600 V440
002		544191100	UPPER PLATE PC-74E SQUARE PLATE
002		544191200	UPPER PLATE PC-78E SQUARE PLATE
002		544191300	UPPER PLATE PC-712E SQUARE PLATE
002		544190800	UPPER PLATE PC-74E ROUND PLATE
002		544190900	UPPER PLATE PC-78E ROUND PLATE
002		544191000	UPPER PLATE PC-712E ROUND PLATE
002		536014700	3 DRILL WHEELS
002		539060200	RED ADESIVE DISK FOR PC-E
002		539054200	STAMP Ø20,5 CR."L" LOTUS R.
002		536034400	KNOB \$77 4P. \$06*4,6 C/M
002		537000300	COMMUTATOR 7 POSITIONS S.49 16A
002		539018900	INDEX FOR KNOB W/RED SIGN
002		537035400	HEATING ELEMENT 00003W 330KOHM W/F
002		537014100	WHITE WARNING LIGHT 250V