

# MAGICLOTUS 60

ELETTRICO / ELECTRIC / ELEKTRO / ELECTRIQUE

## CWT-64ET CWT-66ET CWT-68ET

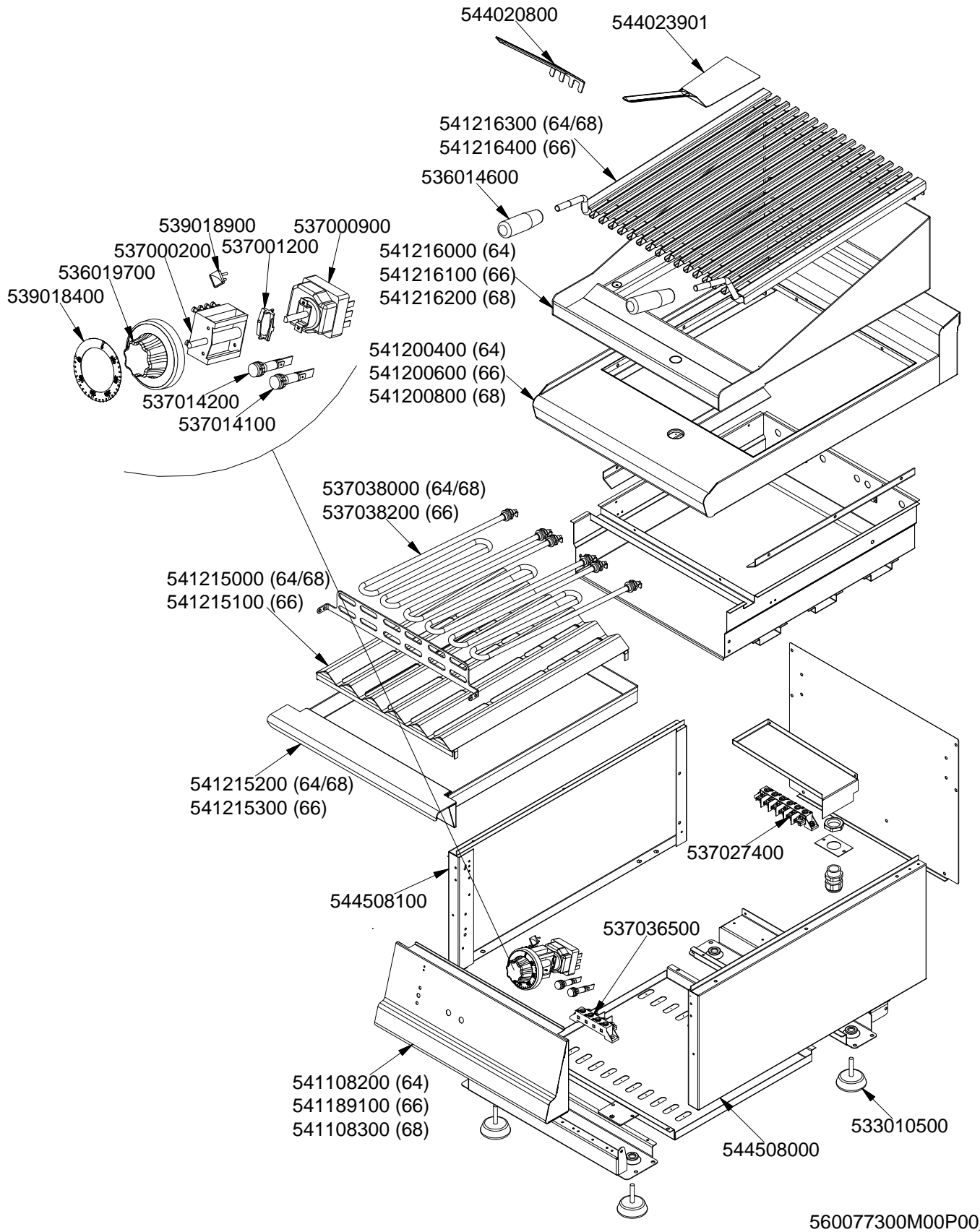

560077300M00P00

Page	Pos	Code	Description
001		544020800	SPATTLE FOR CW S70 S90
001		544023901	SPATTLE FOR FRY-TOP
001		541216300	GRID CWT-64
001		536014600	GRIP D.28*90*M10 CW
001		539018900	INDEX FOR KNOB
001		537000200	COMMUTATOR 1 POS. 3PHASE S.49 16A
001		536019700	BLACK KNOB §70 PIN §6*5
001		539018400	ADHESIVE GRADUATED DISC FOR KNOB
001		537000900	THERMOSTAT 50-320°C THREEPHASE
001		537001200	FIXING BRACKET FOR THERMOSTAT/COMM.
001		541216200	SPLASH GUARD CWT-68
001		541200800	UPPER PLATE CWT-68E
001		537014200	GREEN WARNING LIGHT 250V
001		537014100	WHITE WARNING LIGHT 250V
001		537038000	ELEMENT CW-64E 1600W 230V
001		541215000	REFLECTING BOARD CW-64E
001		541215200	DRIP TRAY CW-64E
001		537027400	TERMINAL BLOCK THREEPHASE 40A
001		544508100	
001		537036500	TERMINAL BLOCK 4POLES 40A SCREW-SCR
001		541108300	CONTROL PANEL CW-78E
001		544508000	
001		533010500	LEG M10*25 D.40