

COMPLEMENTI ELETTRICI / OTHER ELECTRIC APPLIANCES / ELEKTRO ZUSATZGERÄTE / COMPLEMENTS NEUTRES ELECTRIQUES

K-6 K-8 K-9 K-10 K-12 K-14 K-15 K-16 K-18 K-20 K-22 K-24 K-26 K-28 K-30 K-6S K-8S K-9S K-10S K-12S K-14S K-15S K-16S K-18S K-20S K-22S K-24S K-26S K-28S K-30S

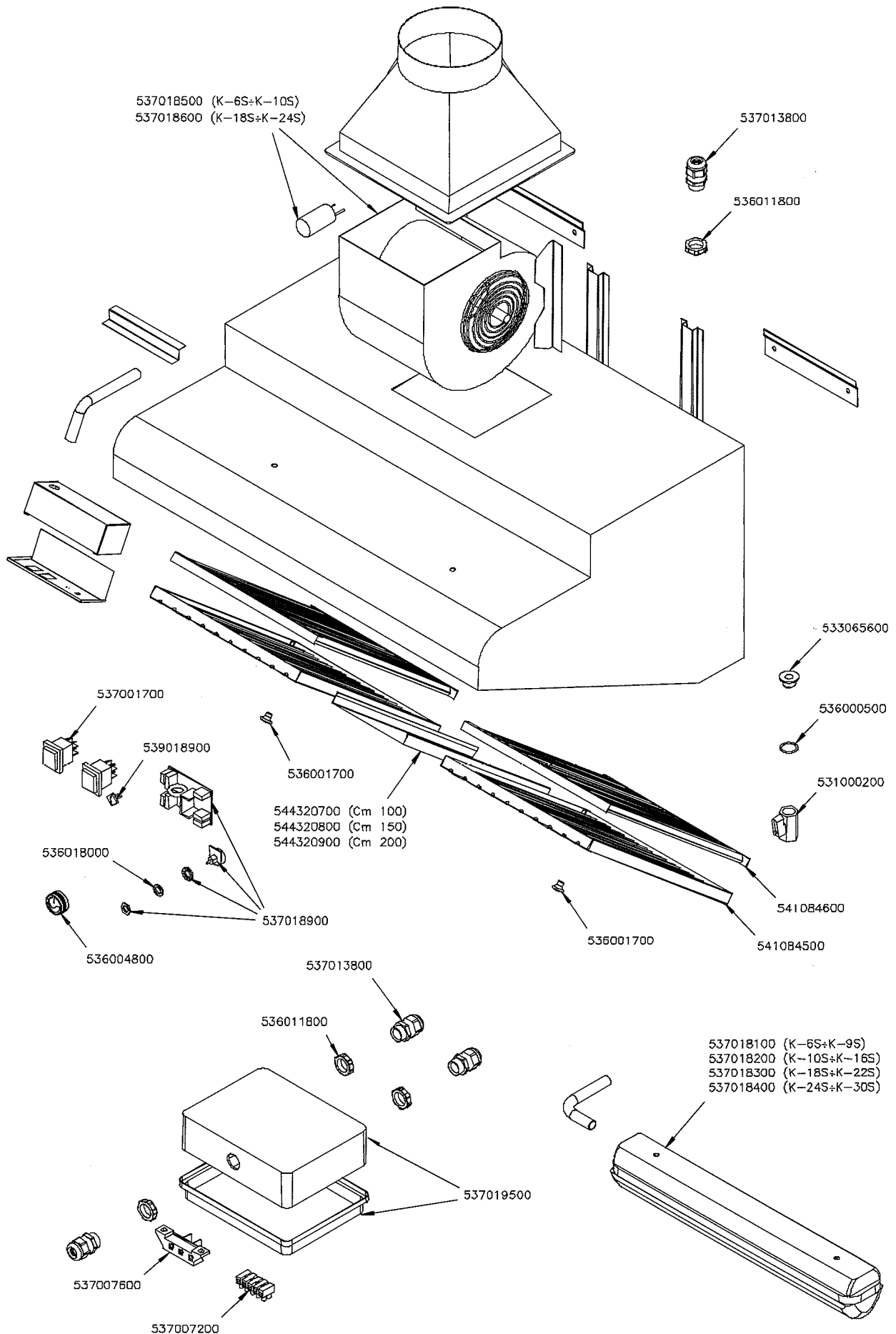

Page	Pos	Code	Description
001		537013800	CABLE SECURING CLAMP PG-13,5
001		536011800	HEXAGONAL LOCK NUT PG-13,5
001		537018600	CENTRIFUGAL FAN DDM 9/9
001		537001700	GREENLIGHTED BIPOLAR SWITCH
001		539018900	INDEX FOR KNOB
001		536001700	GRIP D.25*19*M6
001		536018000	
001		544320700	PANEL FOR HOOD 100
001		544320800	PANEL FOR HOOD 150
001		544320900	PANEL FOR HOOD 200
001		536004800	KNOB FOR GRADUATED REGULATOR
001		537018900	ELECTRONIC BOARD REGULATOR 600W
001		541084600	BACK HOOD FILTER
001		541084500	FACE HOOD FILTER
001		533065600	FITTING FOR HOOD UNLOADING 3/8"G
001		536000500	O-RING FOR MINISIT FITTING
001		531000200	DRAIN COCK 3/8" FOR CANOPY
001		537018400	HOOD BULB L=1570 WITH NEON
001		537019500	ELECTRIC BOX FOR CANOPY
001		537007600	TERMINAL BLOCK SINGLEPHASE 40A
001		537007200	5POLES TERMINAL BLOCK PA 27 WP NY