

Seite	Position	Kreditorart.Nr	GB	DE
001	001	183149	power control element 220 V	Energieregler 220 V
001	002	814957000	support panel	Halteblech
001	003	070516	sealing plate	Dichtplatte
001	004	895652002	angle hinge, left	Scharnierwinkel links
001	004	895653002	angle hinge, right	Scharnierwinkel rechts
001	005	184120	indicator light green 220V	Leuchtmelder grün 220V
001	006	985284002	switch panel	Schalterblende
001	007	189009	knob with flat spring black	Knebel mit Blattfeder schwarz
001	008	141078	scale ring f. bain-marie (VAR-027)	Skalenring (VAR-027)
001	009	184118	indicator light 220V white	Leuchtmelder 220V weiß
001	010	808069002	wing door left	Flügeltür links
001	011	895654002	lower angle hinge	Scharnierwinkel unten
001	012	802754100	drawer	Schublade
001	013	814392000	base	Boden
001	014	732752000	splash guard	Spritzschutzrahmen
001	015	986593002	pillow block right	Lagerbock rechts
001	015	986592002	pillow block left	Lagerbock links
001	016	142655	side appliance strip right	Geräteseitenleiste rechts
001	016	142654	side appliance strip left	Geräteseitenleiste links
001	017	172291	permanent magnetic lock	Dauermagnetverschluß
001	018	132063	plastic handle	Kunststoffgriff
001	018	062140	handle insert	Griffeinlage
001	019	143642	side fascia element right	Blendenseitenteil rechts
001	019	143643	side fascia element left	Blendenseitenteil links
001	020	061298	foot	Fuß
001	021	80807002	wing door right	Flügeltür rechts
001	022	815991010	lower panel	Blende unten

27

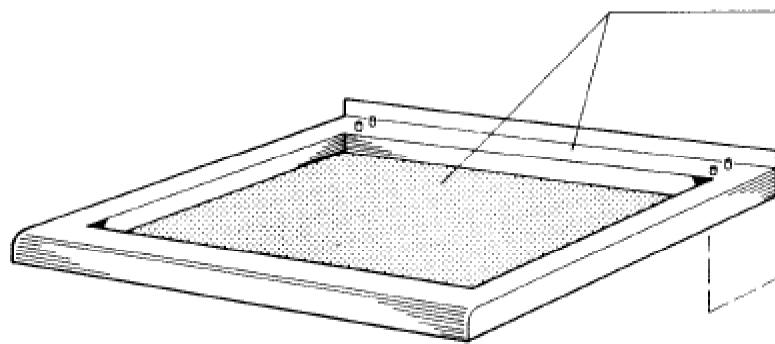

28



29

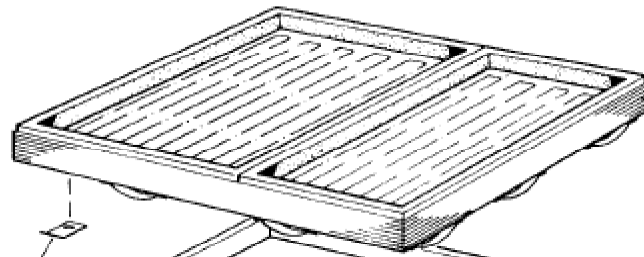

30

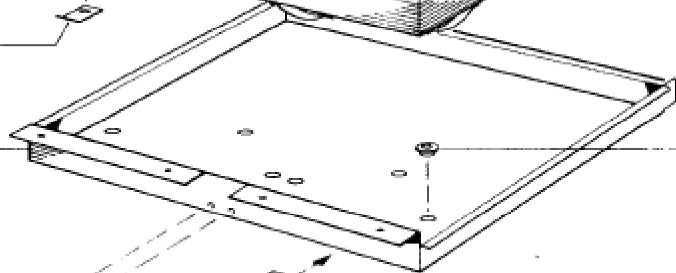

31



32

33

34

35

36

23

24

25

26



Seite	Position	Kreditorart.Nr	GB	DE
003	023	816976000	strain relief	Zugentlastung
003	024	986619002	heating box	Heizraumkasten
003	025	985275002	grease chute	Schmutzrohr
003	026	185890	mini-contactor DIL 04-40	Kleinschütz DIL 04-40
003	027	987074002	top frame assembly complete	BG-Oberplatte komplett
003	028	732239000	holding bracket	Haltewinkel
003	029	987071006	heating element box assembled 380 V	Heizkörperkasten montiert 380 V
003	029	987070006	heating element box assembled 220 V	Heizkörperkasten montiert 220 V
003	030	187003	through-line	Durchführung
003	031	156953	snap washer	Sprengring
003	032	185576	terminal 2,5 mm2	Apparate-Klemme 2,5 mm2
003	033	185575	junction terminal 3x4 mm ²	Durchgangsklemme 3x4 mm ²
003	033	185575	junction terminal 3x4 mm ²	Durchgangsklemme 3x4 mm ²
003	033	185574	stop plate 3x4 mm ²	Abschlußplatte 3x4 mm ²
003	033	185587	end holder Typ 209 -101	Endhalter Typ 209 -101
003	034	185589	protective conductor clamp 16 mm ²	Schutzleiterklemme 16 mm ²
003	035	184683	safety clamp	Sicherungsklemme
003	035	184683	safety clamp	Sicherungsklemme
003	035	186276	stop plate	Abschlußplatte
003	036	216325	fine-wire fuse 4 A	Feinsicherung 4 A
003	036	216325	fine-wire fuse 4 A	Feinsicherung 4 A