

CF-8EM      CF-8ET  
CF-8EM/A    CF-8ET/A

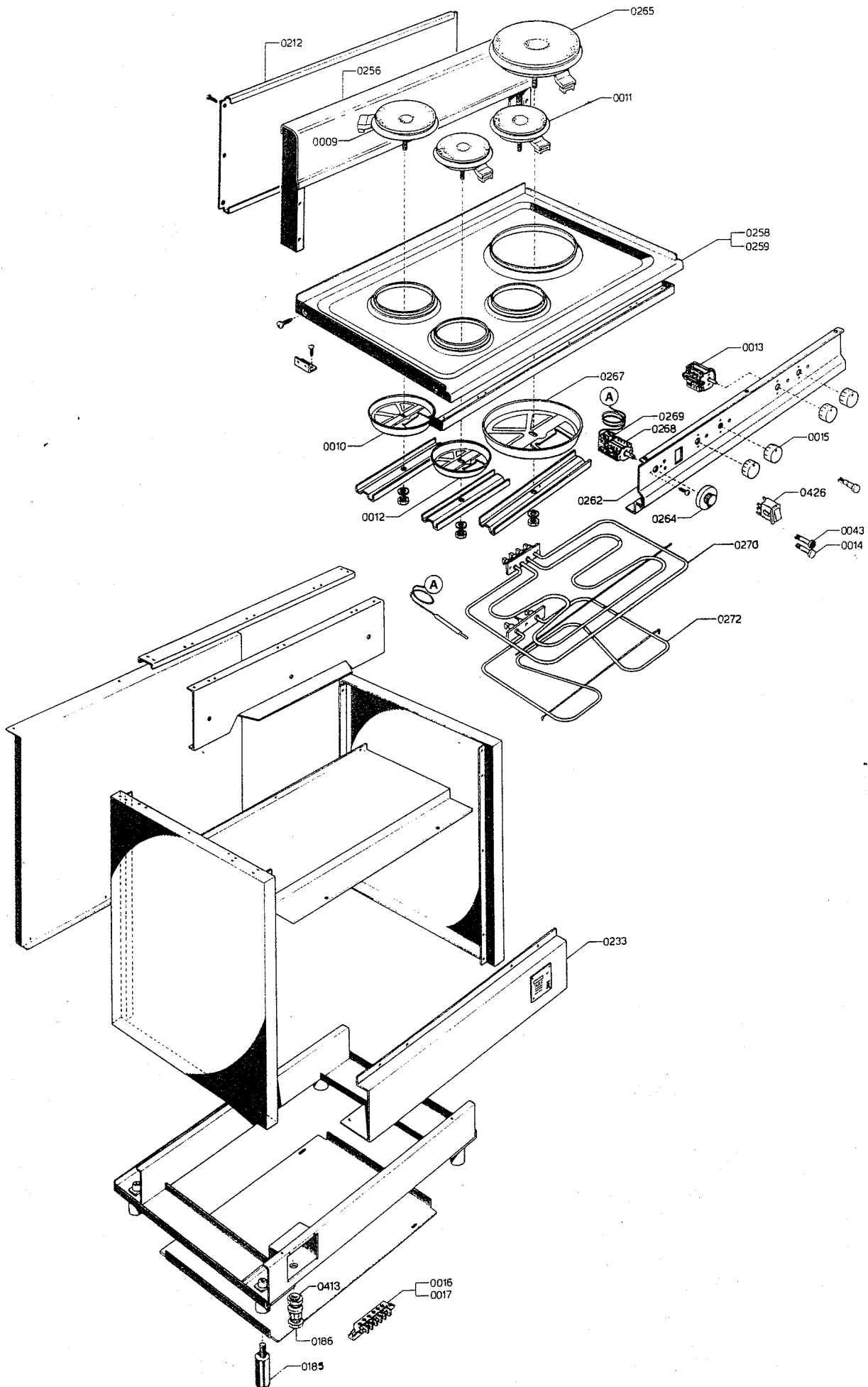

CF-8ET  
CF-8ET/A

CF-8EM  
CF-8EM/A

CF-10ET  
CF-10ET/A

CF-10EM  
CF-10EM/A

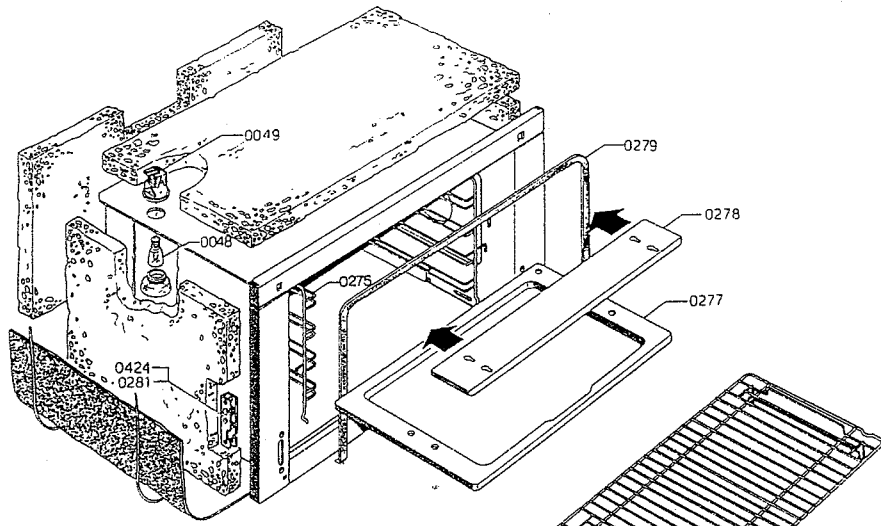

PORTA COMPLETA 0287

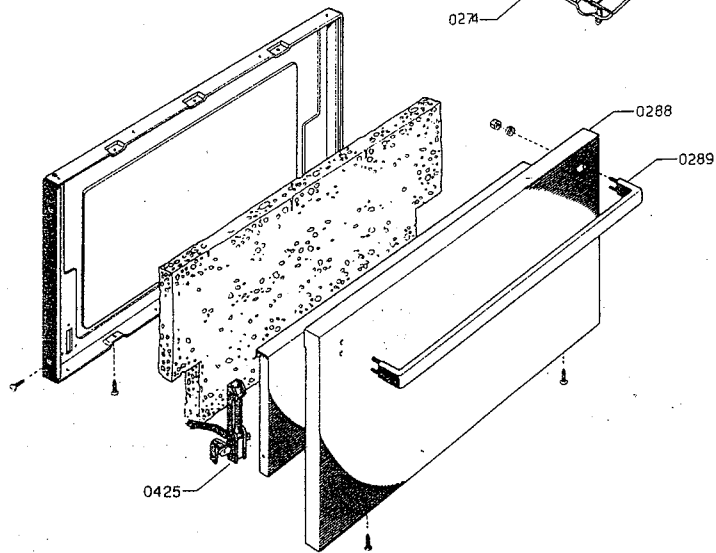

PORTA COMPLETA 0282

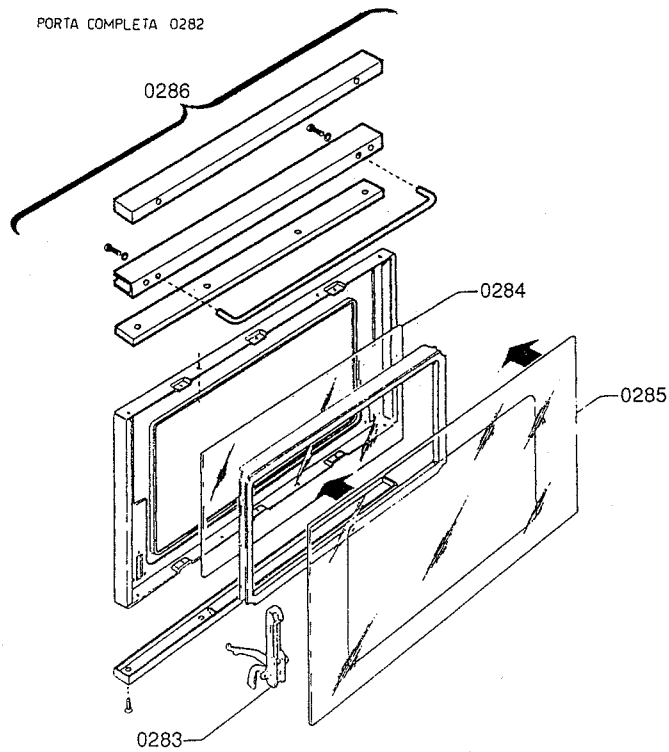

NR.	COD.	DESCRIZIONE - BESCHREIBUNG - DESCRIPTION - DESCRIPTION	DM.
009	53.7.0022.00	Piastra Ø180 W1500 V230 Heizplatte Ø180 W1500 V230 Plaque électrique Ø180 W1500 V230 Electrical plate Ø180 W1500 V230	49
010	53.7.0025.00	Coperchio Ø180 Deckel für Heizplatte Ø180 Couvercle plaque électrique Ø180 Plate cover Ø180	6
011	53.7.0021.00	Piastra Ø145 W1000 V230 Heizplatte Ø145 W1000 V230 Plaque électrique Ø145 W1000 V230 Plate cover Ø145 W1000 V230	45
012	53.7.0024.00	Coperchio Ø145 Deckel für Heizplatte Ø145 Couvercle plaque électrique Ø145 Plate cover Ø145	5
013	53.7.0003.00	Commutatore 7 pos. Umschalter 7 Pos. Commutateur 7 pos. Commutator 7 pos.	16
014	53.7.0141.00	Spia bianca Kontrolllampe weiss Lampe témoin blanche White warning light	5
015	53.6.0021.00	Manopola 7 pos. Siebentaktknobel Manette 7 pos. Knob 7 pos.	4
016	53.7.0076.00	Morsettiera monofase 40A Anschlussklemmenbrett einphasig 40A Plaque à bornes monophasé 40A Terminal block singlephase 40A	9
017	53.7.0077.00	Morsettiera trifase 40A Anschlussklemmenbrett dreiphasig 40A Plaque à bornes triphasé 40A Terminal block threephase 40A	11
043	53.7.0142.00	Spia verde Kontrolllampe grün Lampe témoin verte Green warning light	5
048	53.7.0054.00	Lampada forno Backofenlampe Ampoule four Oven bulb	16
049	53.7.0079.00	Portalampada forno Backofen-Fassung Porte-ampoule four Oven bulb-socket	31
185	53.1.0081.00	Piede h.9 cromato Fuss h.9 verchromt Pied h.9 chromé Leg h.9 chrome	7
186	53.7.0140.00	Pressacavo V.TEC 21 Kabelklemme V.TEC 21 Serre-câble V.TEC 21 Cable securing clamp V.TEC 21	5

NR.	COD.	DESCRIZIONE - BESCHREIBUNG - DESCRIPTION - DESCRIPTION	DM.
212	54.4.1318.00	Retro distanziale 800 Rück-Distanzstück 800 Arrière entretoise 800 Back-spacer 800	18
213	54.4.1319.00	Retro distanziale 1000 Rück-Distanzstück 1000 Arrière entretoise 1000 Back-spacer 1000	21
233	54.4.0445.00	Frontale inferiore Unteres Frontteil Panneau avant du bas Lower frontal piece	32
256	54.1.0269.00	Distanziale 800 neutro Neutrales Distanzstück 800 Entretoise neutre 800 Neutral spacer 800	70
257	54.1.0270.00	Distanziale 1000 neutro Neutrales Distanzstück 1000 Entretoise neutre 1000 Neutral spacer 1000	82
258	54.4.0437.00	Piano Oberplatte Plan Upper plate	CF-8E 103
259	54.4.2162.00	Piano Oberplatte Plan Upper plate	CF-8E/A 105
260	54.4.0436.00	Piano Oberplatte Plan Upper plate	CF-10E 122
261	54.4.2164.00	Piano Oberplatte Plan Upper plate	CF-10E/A 122
262	54.4.0442.01	Cruscotto Bedienungsblende Bandeau Control panel	CF-8E 32
263	54.4.0441.01	Cruscotto Bedienungsblende Bandeau Control panel	CF-10E 34
264	53.6.0028.00	Manopola forno Backofen-Knebel Manette four Oven knob	CF-8E 5
265	53.7.0023.00	Piastra Ø220 W2000 V230 Heizplatte Ø220 W2000 V230 Plaque électrique Ø220 W2000 V230 Electrical plate Ø220 W2000 V230	103
267	53.7.0026.00	Coperchio Ø220 Deckel für Heizplatte Ø220 Couvercle plaque électrique Ø220 Plate cover Ø220	16

NR.	COD.	DESCRIZIONE - BESCHREIBUNG - DESCRIPTION - DESCRIPTION	DM.
268	53.7.0057.00	Commutatore forno Backofen-Umschalter Commutateur four Oven commutator	42
269	53.7.0061.00	Termostato forno Backofen-Thermostat Thermostat four Oven thermostat	67
270	53.7.0062.00	Resistenza superiore forno W1050+2000 V230 Oberheizkörper für Backofen W1050+2000 V230 Résistance haut four W1050+2000 V230 Upper oven heating element W1050+2000 V230	72
272	53.7.0063.00	Resistenza inferiore forno W1750 V230 Unterheizkörper für Backofen W1750 V230 Résistance bas four W1750 V230 Lower oven heating element W1750 V230	62
274	53.1.0067.00	Griglia forno Backofenrost Grille four Oven grid	46
275	53.1.0136.00	Griglia laterale forno Seitenrost für Backofen Grille latérale four Oven side grid	38
277	53.4.0022.00	Leccarda forno Backofen-Fettfänger Lèche-frite four Oven dripping-pan	50
278	53.4.0091.00	Protezione grill Grillschutz Protection grill Grill protection	33
279	53.6.0113.00	Guarnizione forno Backofen-Dichtung Joint four Oven gasket	26
281	53.1.0124.00	Portarullino porta vetro CF-8/10 Rollenhalterung für Glastür CF-8/10 Support rouleau porte en verre CF-8/10 Wheel holder for glass door CF-8/10	12
282	53.1.0096.00	Porta vetro forno completa Backofenglastür komplett Porte four complète en verre Complete glass oven door	186
283	53.1.0073.00	Cerniera porta vetro Scharnier für Glastür Charnière pour porte en verre Glass door hinge	29
284	53.6.0071.00	Vetro interno porta forno 565x316 Innenglassscheibe für Backofentür 565x316 Verre intérieur porte four 565x316 Internal glass for oven door 565x316	35
285	53.6.0070.00	Vetro esterno porta forno 725x446 Aussenglassscheibe für Backofentür 725x446 Verre extérieur porte 725x446 External glass for oven door 725x446	107

NR.	COD.	DESCRIZIONE - BESCHREIBUNG - DESCRIPTION - DESCRIPTION	DM.
286	53.1.0070.00	Maniglia porta vetro forno Griff für Backofenglastür Poignée porte four en verre Glass oven door handle	106
288	54.4.0747.00	Pannello inox porta forno Nirosterpaneel Backofentür Panneau inox porte four Stainless steel oven door panel	53
289	54.1.0252.00	Maniglia cromata porta forno Griff für Edelstahltür Poignée porte four inox Stainless steel oven door handle	36
413	53.6.0120.00	Controdado esagonale PG-21 Sechskantgegenmutter PG-21 Contre-écrou hexagonal PG-21 Hexagonal lock nut PG-21	3
424	53.1.0079.00	Portarullino porta cieca CF-8/10 Rollenhalterung für Edelstahltür CF-8/10 Support rouleau porte inox CF-8/10 Stainless steel oven door wheel holder CF-8/10	12
425	53.1.0082.00	Cerniera porta cieca Scharnier für Edelstahltür Charnière pour porte inox Hinge for stainless steel door	29
426	53.7.0155.00	Interruttore bipolare luminoso rosso Zweipoliger Leuchtschalter rot Interrupteur bipolaire lumineux rouge Red backlighted bipolar switch	4