

Seite	Position	Kreditorart.Nr	GB	DE
001	001	064303	symbol mask for electronics	Symbolmaske für Elektronik
001	002	151500	pressure gauge	Druckmeßgerät
001	003	061135	spacing roll	Distanzrolle
001	004	146205	hinge bearing adjustment disc	Drehlager-Einstellscheibe
001	005	943443002	lid with handle	Deckel mit Griff
001	006	070531	profile packing (for cover) 20 x 12 mm	Profilschnur (Deckeldichtung) 20 x 12 mm
001	007	800424010	front panel, fascia	Frontblende
001	008	941053002	control panel assembly	BG-Schalterblende
001	009	062300	foot of the unit	Gerätefuß
001	010	260264	hose clamp 13 mm	Schlauchschelle 13 mm
001	011	152424	regulator	Regler
001	012	071261	low pressure hose	Niederdruckschlauch
001	013	062214	y-shaped hose connecting piece	Y-Schlauchverbindungsstutzen
001	014	738509000	cladding for pillow block right	Verkleidung für Lagerbock rechts
001	014	738508000	cladding for pillow block left	Verkleidung für Lagerbock links
001	015	140309	cheese head screw DIN912	Zylinderschraube DIN912
001	016	134358	upper bearing block	Lagerbock oben
001	017	134359	lower bearing block	Lagerbock unten
001	018	806325000	fascia	Blende
001	019	100105	manufacturer's label Küppersbusch	Firmenschild Küppersbusch
001	020	130918	side appliance strip left	Geräteseitenleiste links
001	020	130919	unit side strip, r.h.	Geräteseitenleiste rechts

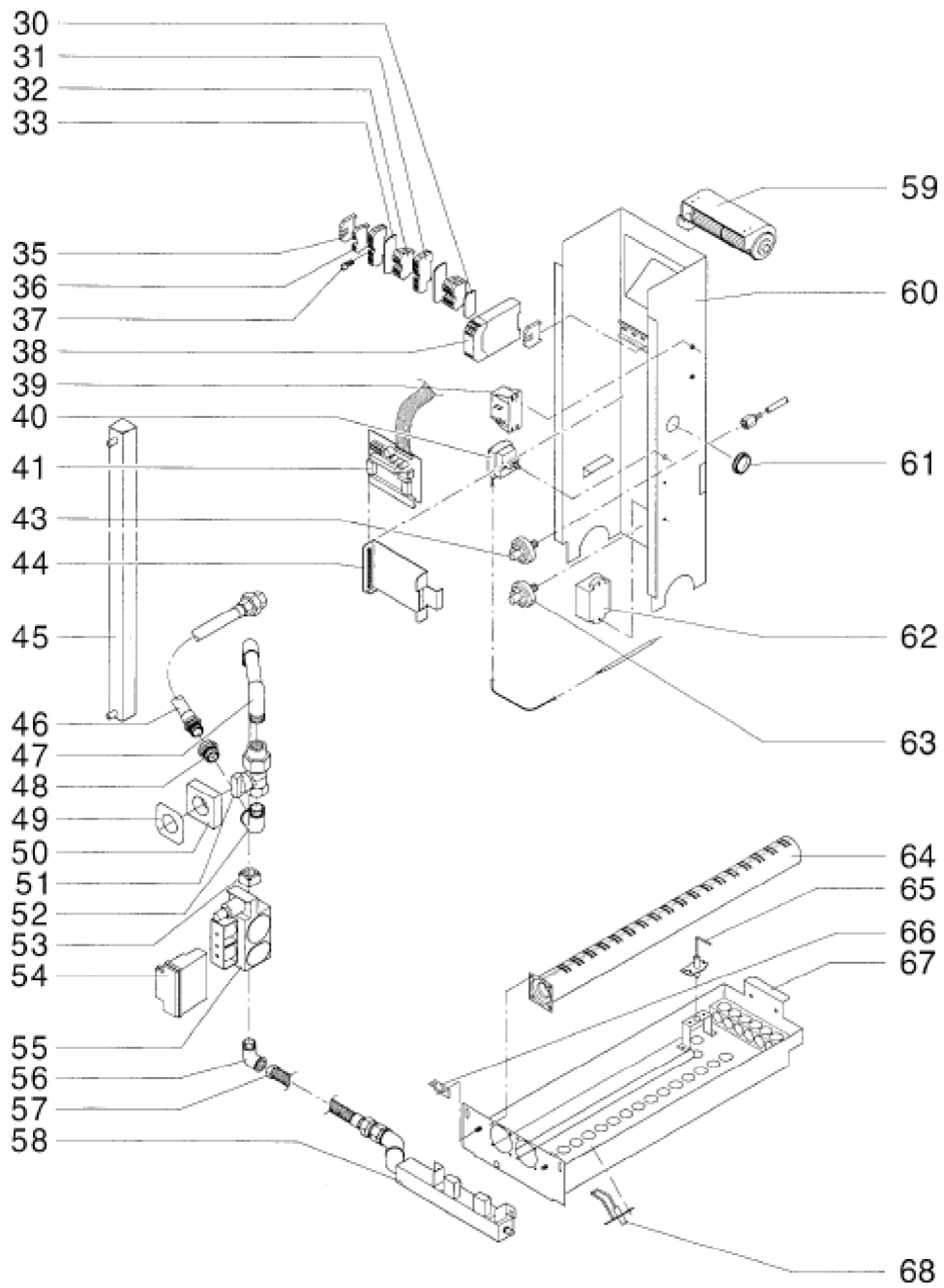

Seite	Position	Kreditorart.Nr	GB	DE
003	030	185592	isolating plate 4mm <sup>2</sup>	Trennplatte 4mm <sup>2</sup>
003	031	185575	junction terminal 3x4 mm <sup>2</sup>	Durchgangsklemme 3x4 mm <sup>2</sup>
003	032	185584	junction terminal 4 mm <sup>2</sup>	Durchgangsklemme 4 mm <sup>2</sup>
003	033	185574	stop plate 3x4 mm <sup>2</sup>	Abschlußplatte 3x4 mm <sup>2</sup>
003	035	185587	end holder Typ 209 -101	Endhalter Typ 209 -101
003	036	185589	protective conductor clamp 16 mm <sup>2</sup>	Schutzleiterklemme 16 mm <sup>2</sup>
003	037	185594	transversal bridge	Querbrücker
003	038	184833	level regulator	Niveauregler
003	039	164700	transformer	Trafo
003	043	150501	swivel faucet valve 3/4"	Schwenkventil 3/4"
003	044	061142	circuit board guide	Leiterplatte Führung
003	044	738664000	holder for PE-relay card	Halter für PE-Relaiskarte
003	045	946348006	condensate pan	Kondensatbehälter
003	046	063602	stainless steel - hose	Edelstahl - Schlauch
003	047	942103002	pipe bend	Rohrbogen
003	048	166082	reducing nipple 3/4x1/2"	Reduziernippel 3/4x1/2"
003	049	738695000	fascia with gas tap	Blende mit Gashahn
003	050	062134	gasket	Dichtung
003	051	151020	Gas connector - globe valve	Gasanschluß - Kugelhahn
003	052	166009	angle	Winkel
003	053	153720	connecting flange 1/2"	Anschlussflansch 1/2"
003	054	164859	firing automaton	Feuerungsautomat
003	055	150126	gas - valve	Gas - Ventil
003	056	166008	angle 1/2"	Winkel 1/2"
003	057	151429	stainless steel - corrugated hose	Edelstahl - Wellenschlauch
003	058	943486002	burner jet assembly	Düsenstock
003	059	178410	fan wheel 230-240V	Querstromlüfter 230-240V
003	060	941654002	connecting sheet	Anschlussblech
003	061	350335	cable protection sleeve KT 21	Kabeltülle KT 21
003	062	164868	interference filter	Störschutzfilter
003	063	176197	pressure switch	Druckschalter
003	064	164401	burner / stainless steel	Brenner / Edelstahl
003	065	162807	detecting device	Fühler
003	066	733504000	holding bracket for oven compartment	Haltewinkel für Brennraumkasten
003	067	942026002	burner box	Brennerkasten
003	068	162809	ignition electrode	Zündelektrode

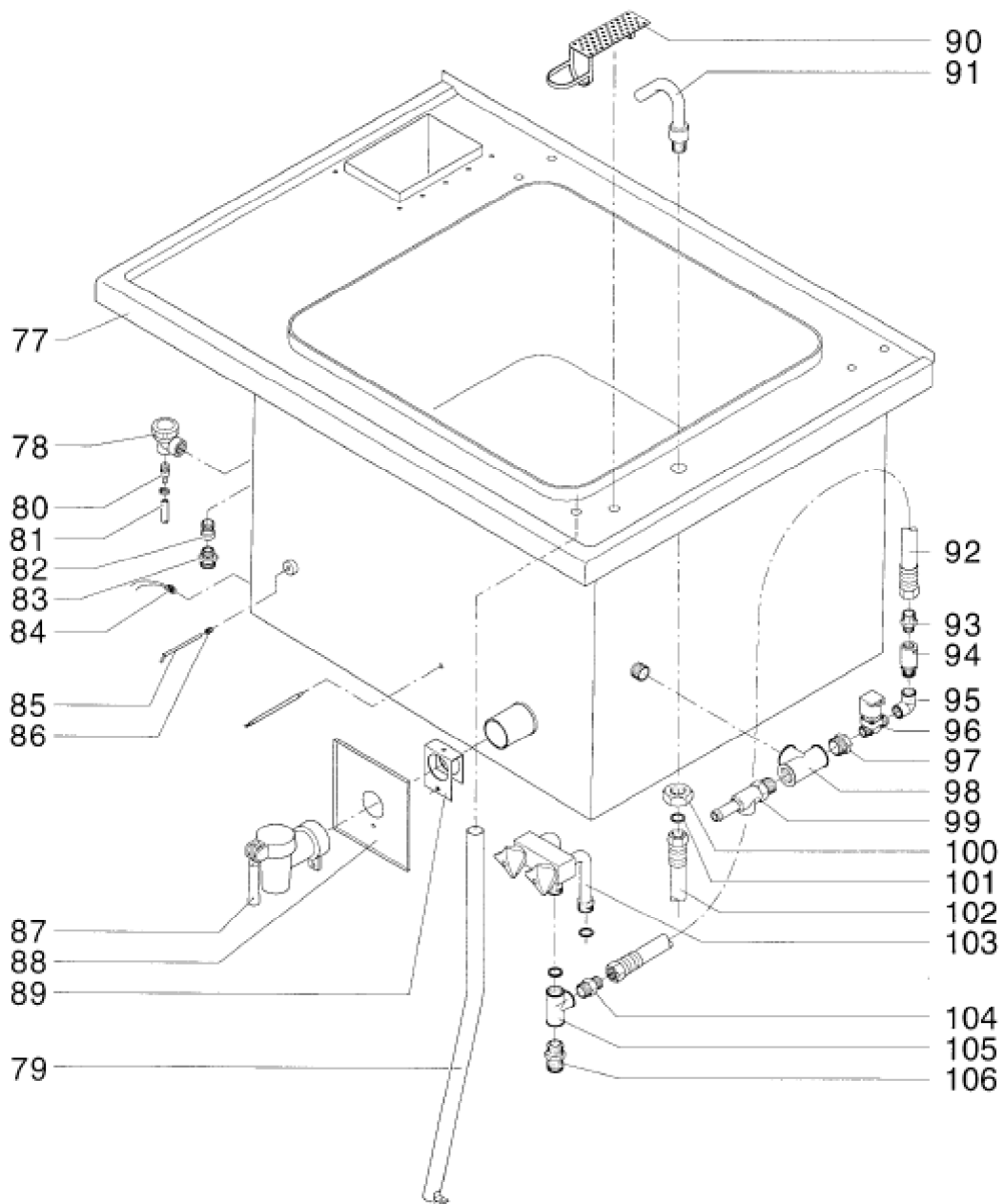

Seite	Position	Kreditorart.Nr	GB	DE
005	077	135220	gas cook pot assembly with top plate	BG-Kessel mit Oberplatte
005	078	150901	Automatic steam vent	Automatischer Dampfentlüfter
005	079	131442	Upper panel drainage	Oberplattenentwässerung
005	080	165309	hose sleeve	Schlauchtülle
005	081	061000	steam hose	Dampfschlauch
005	082	151800	connection Backflow impeder	Anschluss Rückflußverhinderer
005	083	166202	nipple	Nippel
005	084	161601	temperature sensor PT100	Temperaturfühler PT100
005	085	983811002	electrode	Elektrode
005	086	166558	crimp fitting straight	Quetschverschraubung gerade
005	087	150302	drain valve 2"	Entleerhahn 2"
005	088	738507000	fascia behind drain valve	Blende hinter Entleerhahn
005	089	992776002	fastening - drain valve	Befestigung - Entleerhahn
005	090	130801	drain strainer	Auslaufsieb
005	091	178419	water inlet 3/4"	Einlaufarmatur 3/4"
005	092	151405	Hose connector flexible 850 lg	Schlauchverbindung flexibel 850 lg
005	093	111109	double nipple	Doppelnippel
005	094	150600	Fuse combination	Sicherungskombination
005	095	166011	angle R 1/2"	Winkel R 1/2"
005	096	164002	solenoid	Magnetventil
005	097	166082	reducing nipple 3/4x1/2"	Reduziernippel 3/4x1/2"
005	098	166053	t-iron 3/4"	T-Stück 3/4"
005	099	151700	safety valve	Sicherheitsventil
005	100	166103	counter nut 3/4"	Gegenmutter 3/4"
005	101	060520	gasket 3/4"	Dichtung 3/4"
005	102	151401	Hose connector flexible 600lg.	Schlauchverbindung flexibel 600lg.
005	103	151603	Mixing valve complete	Mischventil kpl.
005	104	111109	double nipple	Doppelnippel
005	106	166204	double nipple 3/4"	Doppelnippel 3/4"