



Kühlschrank 700 I, GN 2/1

Artikel-Nr.

90621056 (7E070INC5P001 / ENERGY 700TN)

Explosionszeichnung / Ersatzteile

Bitte bei Ersatzteilbestellung immer Artikelnummer und
Seriennummer mit angeben!

7E070INC5P001-CABINET 700 TN INC. ENERGY

Content filters: validity 11/09/2018

11/09/2018

7E070INC5P001 - 7E070INC5P001-CABINET 700 TN INC. ENERGY..... 3
 7E070INC5P001-OPT - EXPLODED VIEW OF OPTIONAL PARTS & FEATURES..... 5
 SC720 - ELECTRICAL WIRING..... 7
Components index..... 8

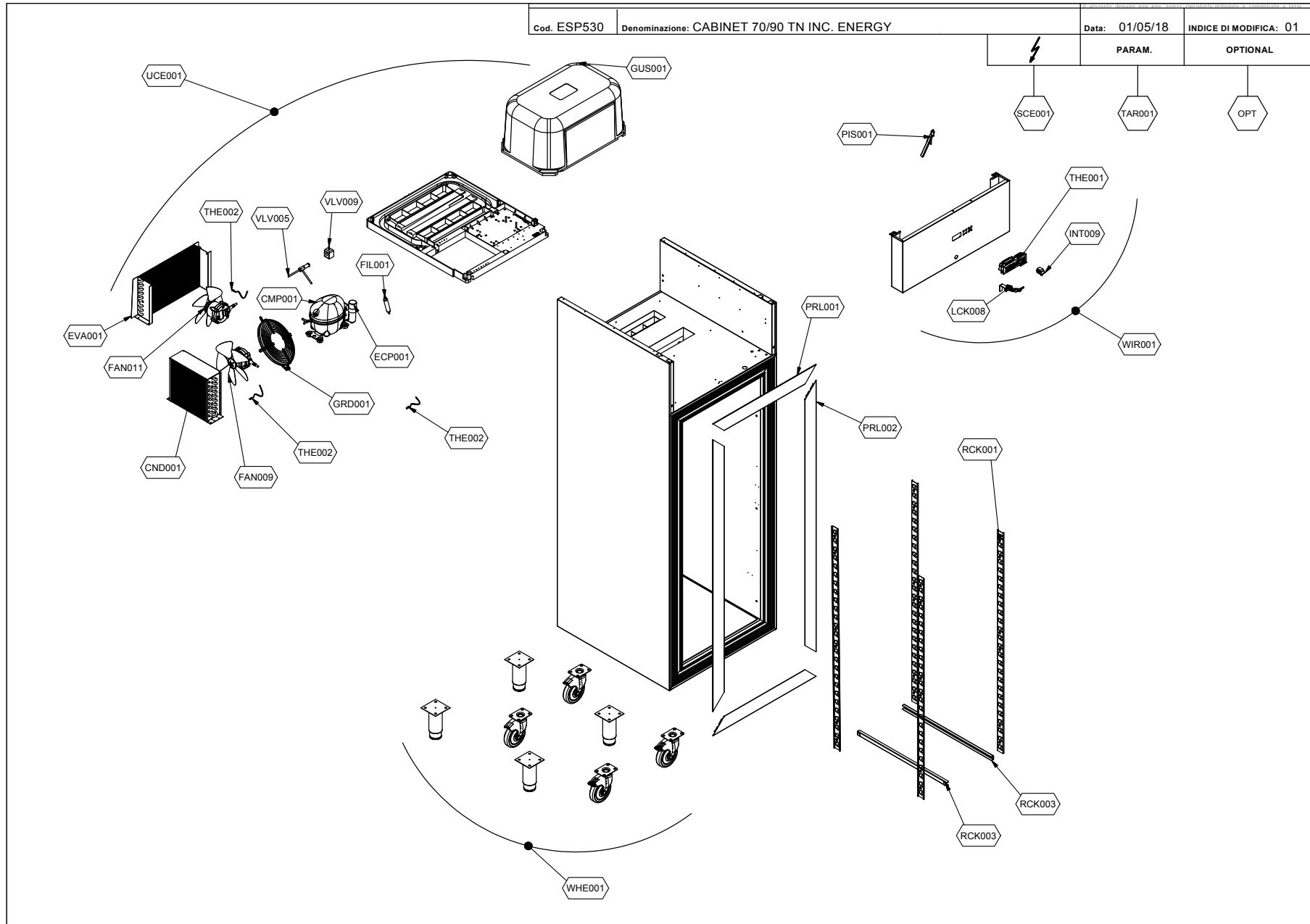

7E070INC5P001-CABINET 700 TN INC. ENERGY - Content filters: validity 11/09/2018

7E070INC5P001 - 7E070INC5P001-CABINET 700 TN INC. ENERGY







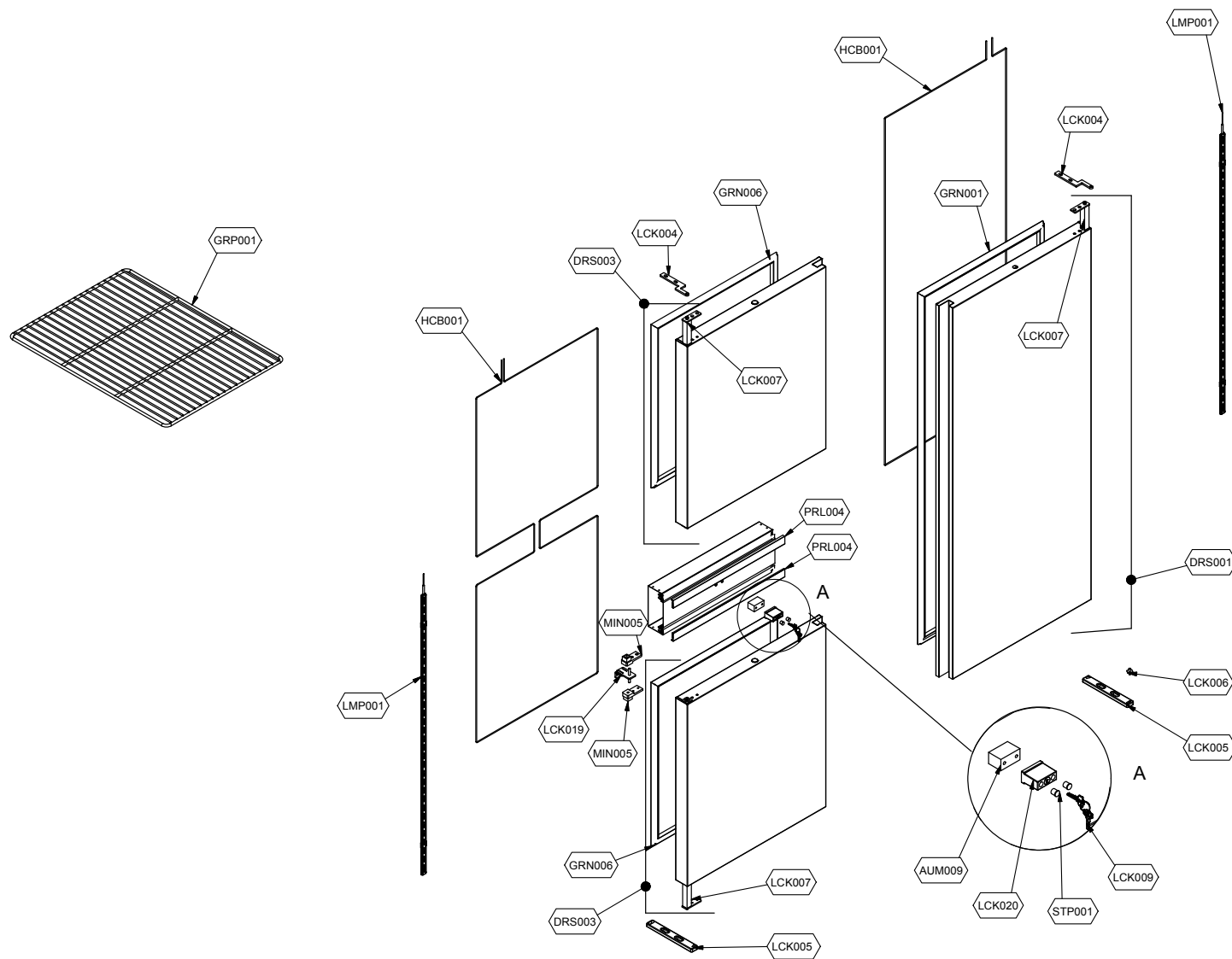

Validity: from 12/05/2017

11/09/2018

Page 3 / 8

Purch.	Pos.	Code	Q.ty	Description	Spare parts after year	Notes
	CMP001	74865562	1	COMPRESSOR	4	
	CND001	74837322	1	CONDENSER	5	
	ECP001	74867120	1	COMPRESSOR ELECTRICAL PARTS	2	
	EVA001	74837306	1	EVAPORATOR	5	
	FAN009	73688642	1	KIT FAN	2	
	FAN011	73688646	1	KIT FAN	2	
	FIL001	74837314	1	FILTER	2	
	GRD001	74837378	1	FAN GRID		
	GUS001	74701641	1	WARM CABLE		
	INT009	78010438	1	MICROSWITCH	2	
	LCK008	73688080	1	LOCK		
	OPT	7E070INC5P001- OPT	1	EXPLODED VIEW OF OPTIONAL PARTS & FEATURES		
	PIS001	74700180	1	PISTON	3	
	PRL001	72609622	1	MOBILE HORIZONTAL COVER		
	PRL002	72609626	1	MOBILE VERTICAL COVER		
	RCK001	74779100	1	UNIVERSAL RACK		
	RCK003	74703270	1	RIGHT RUNNER		
	SCE001	SC720	1	ELECTRICAL WIRING	1	
	TAR001	RIF.TAR.P01	1	CONTROLLER PRESETTING SERVICE	1	
	THE001	74700889	1	UNSETTED ELECTRONIC CONTROLLER	1	
	THE002	74700917	1	PROBE	1	
	UCE001	74861152	1	FULL CONDENSING UNIT		
	VLV005	74700342	1	ELECTROVALVE	4	
	VLV009	74700340	1	ELECTROVALVE	4	
	WHE001	74702570	1	CASTOR/FEET		
	WIR001	73691880	1	ELECTRICAL PANEL		



Purch.	Pos.	Code	Q.ty	Description	Spare parts after year	Notes
	DRS001	73692250	1	DOOR		
	FAN009	73688646	1	KIT FAN	2	
	GRN001	74703384	1	GASKET	2	
	LCK005	74708202	1	LOWER DOOR SUPPORT		
	LCK006	74708126	1	BOTTOM HINGE		
	LMP001	74755590	1	LED LIGHTING		
	THE003	74701161	1	LED POWER PACK	1	
	WHE001	74702570	1	CASTOR/FEET		

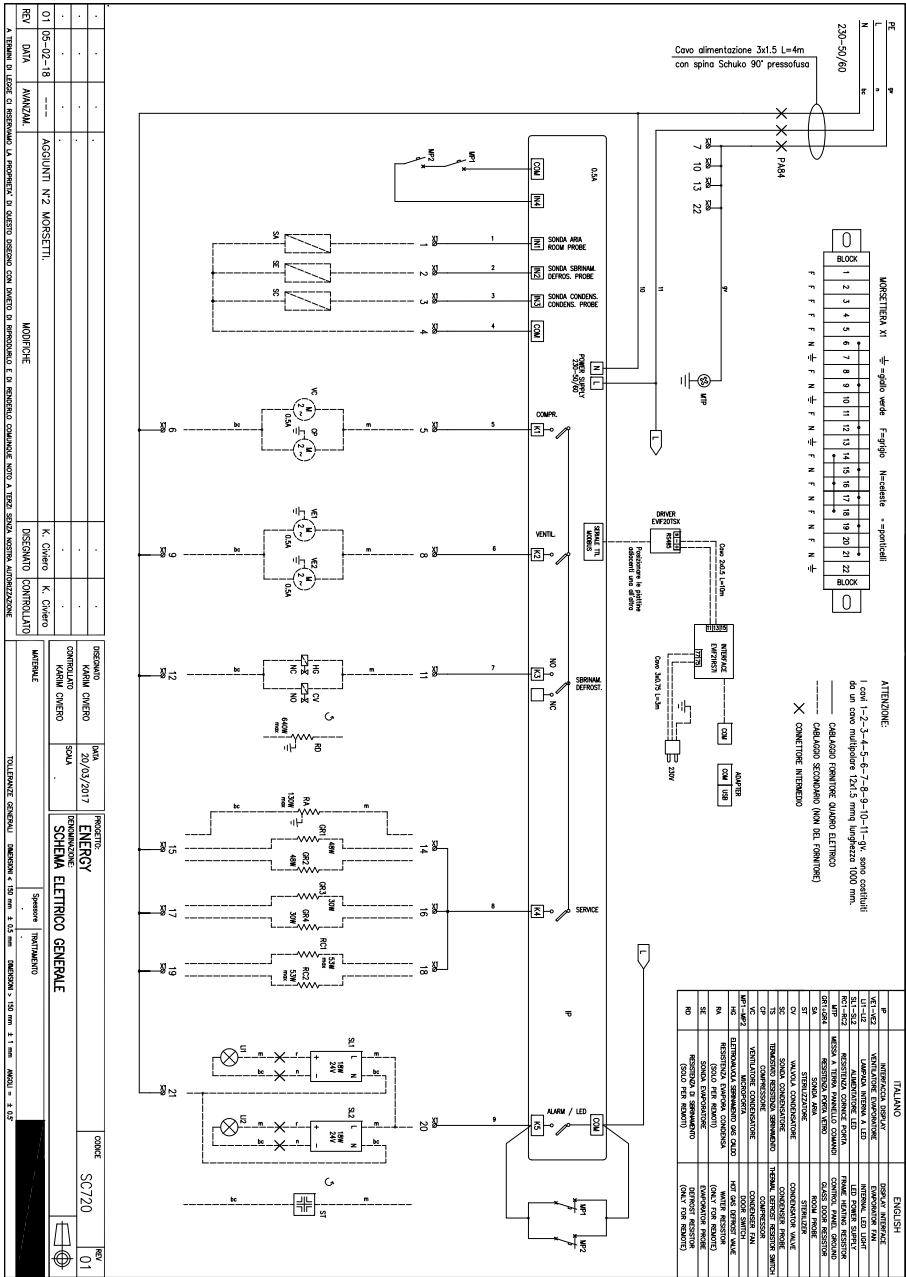

REV.	DATA	MANUALE	MODIFICHE	DISCANTO	CONTROLLO
01	05-02-18	---	AGGIUNTI VZ MORSETTI.	K. Chiaro	K. Chiaro

PROGETTO	DATA	REVISIONI	PRODOTTORE
ENERGY	20/03/2017	---	SCHEMA ELETTRICO GENERALE

DISCANTO	DATA	PRODOTTORE
CONTROLLO	20/03/2017	SCHEMA ELETTRICO GENERALE

REVISIONI	DATA	REVISIONI	PRODOTTORE
---	---	---	---

REVISIONI	DATA	REVISIONI	PRODOTTORE
---	---	---	---

Code	Parts Table	Pos.	Q.ty
72609622	7E070INC5P001	PRL001	1
72609626	7E070INC5P001	PRL002	1
73688080	7E070INC5P001	LCK008	1
73688642	7E070INC5P001	FAN009	1
73688646	7E070INC5P001	FAN011	1
	7E070INC5P001- OPT	FAN009	1
73691880	7E070INC5P001	WIR001	1
73692250	7E070INC5P001- OPT	DRS001	1
74700180	7E070INC5P001	PIS001	1
74700340	7E070INC5P001	VLV009	1
74700342	7E070INC5P001	VLV005	1
74700889	7E070INC5P001	THE001	1
74700917	7E070INC5P001	THE002	1
74701161	7E070INC5P001- OPT	THE003	1
74701641	7E070INC5P001	GUS001	1
74702570	7E070INC5P001	WHE001	1
	7E070INC5P001- OPT	WHE001	1
74703270	7E070INC5P001	RCK003	1
74703384	7E070INC5P001- OPT	GRN001	1
74708126	7E070INC5P001- OPT	LCK006	1
74708202	7E070INC5P001- OPT	LCK005	1
74755590	7E070INC5P001- OPT	LMP001	1
74779100	7E070INC5P001	RCK001	1
74837306	7E070INC5P001	EVA001	1
74837314	7E070INC5P001	FIL001	1
74837322	7E070INC5P001	CND001	1

Code	Parts Table	Pos.	Q.ty
74837378	7E070INC5P001	GRD001	1
74861152	7E070INC5P001	UCE001	1
74865562	7E070INC5P001	CMP001	1
74867120	7E070INC5P001	ECP001	1
78010438	7E070INC5P001	INT009	1
RIF.TAR.P01	7E070INC5P001	TAR001	1