

MAGIC SNACK 60

GAS / GAS / GAS / GAZ

CW-61G CW-62G

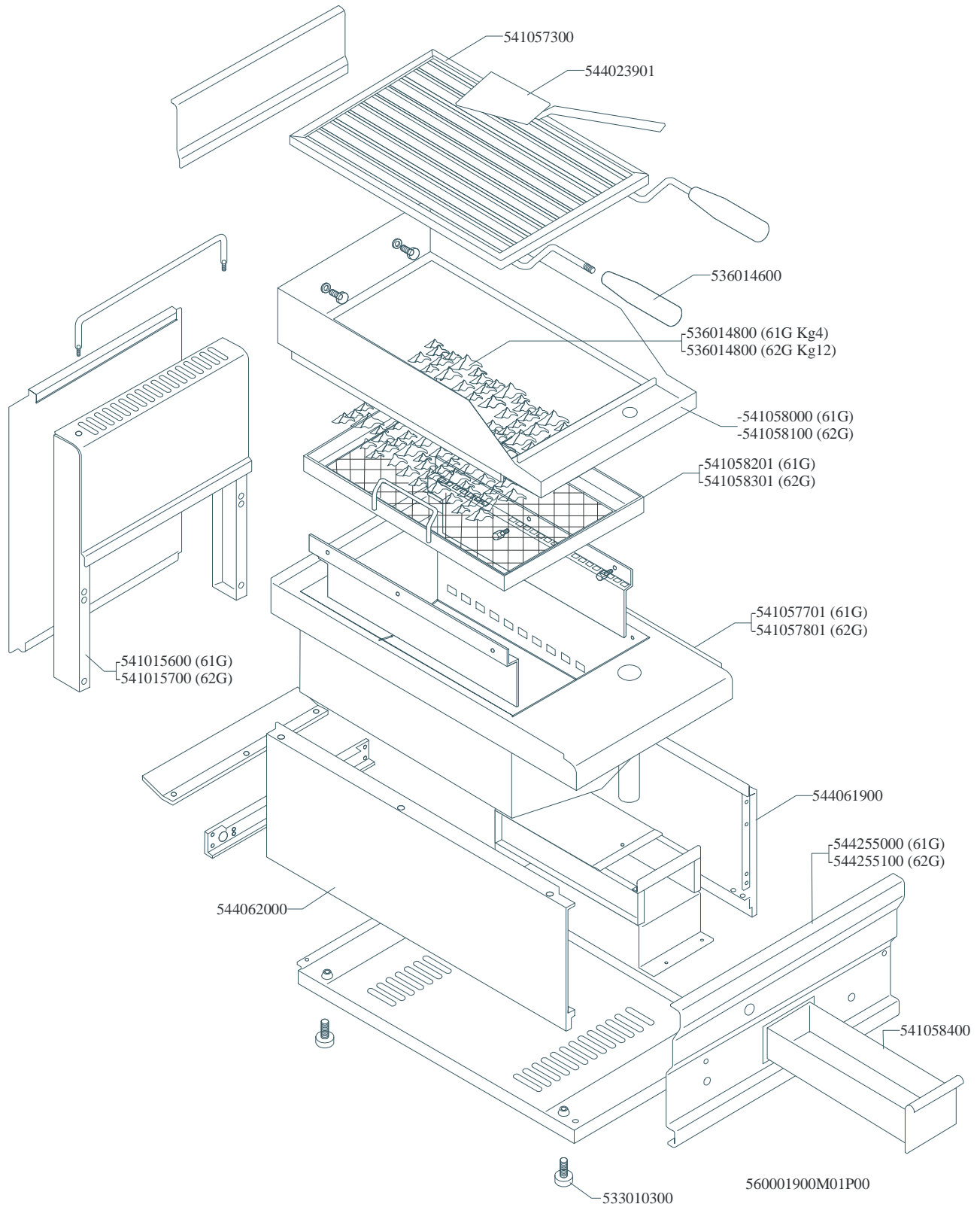

MAGIC SNACK 60

GAS / GAS / GAS / GAZ

CW-61G CW-62G

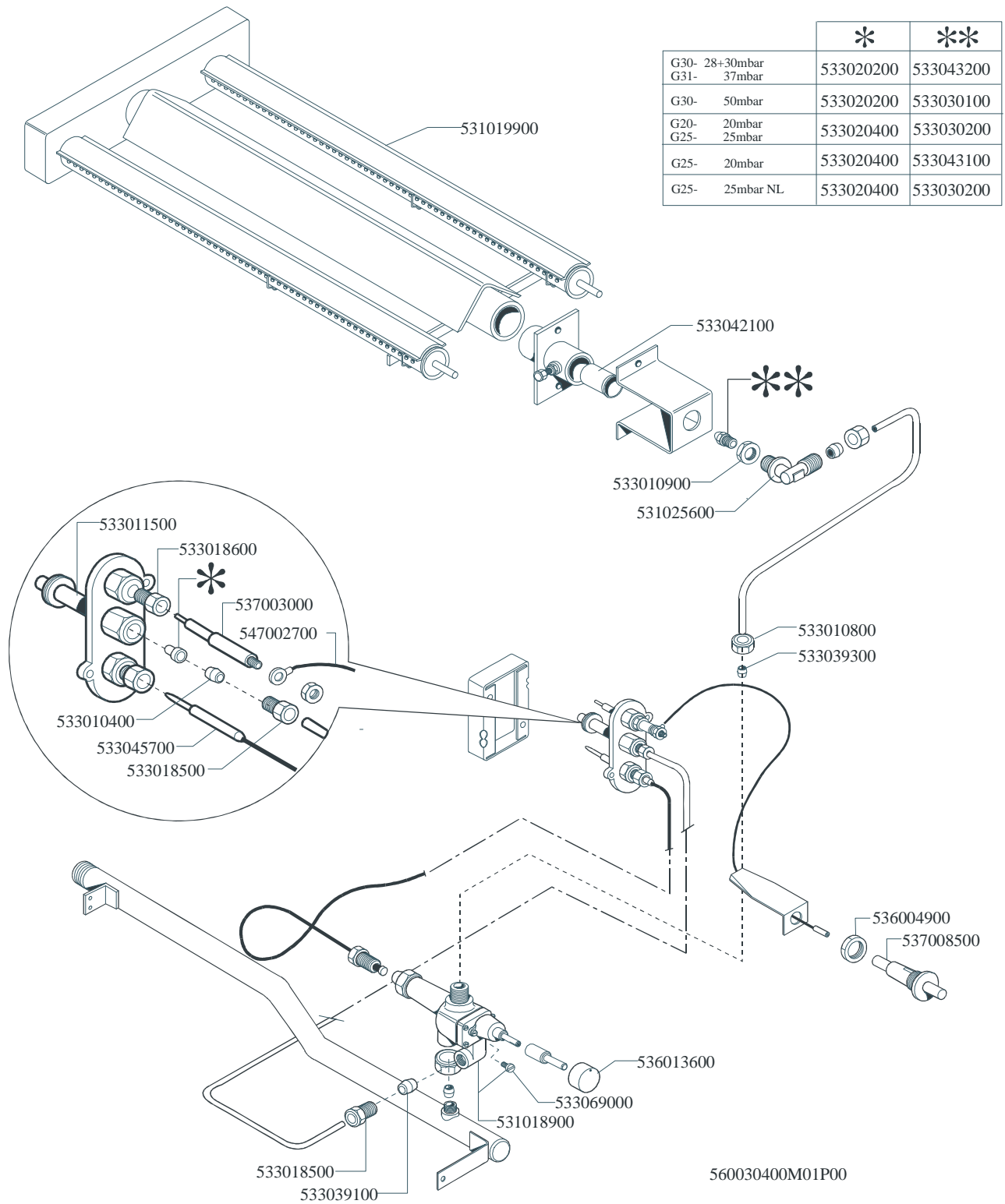

Page	Pos	Code	Description
001		541057300	GRID CW
001		544023901	SPATTLE FOR FRY-TOP
001		536014600	GRIP D.28*90*M10 CW
001		536014800	LAVASTONE
001		541058100	SPLASH SHIELD CW-62G
001		541058301	STONE SUPPORTING FRAME CW-62G
001		541057801	UPPER PLATE CW-62G
001		541015700	PERFORATED SPACER 62
001		544061900	RIGHT SIDE PANEL 60 LINE
001		544255100	CONTROL PANEL CW-62G
001		541058400	DRIP TRAY CW-G
001		544062000	LEFT SIDE PANEL 60 LINE
001		533010300	ADJUSTABLE FOOT M10*20 D.23
002		531019900	BURNER CW-G 60-65-70 LINES
002		533042100	AIR ADJUSTMENT BUSHING CW-G
002		533010900	NUT M14*1 H.4
002		531025600	ELBOW 90° NOZZLE-HOLDER §10 PIPE
002		533010800	TUBE NUT D.10 M16*1,5
002		533039300	BICONE §10
002		533011500	PILOT BURNER 2 FLAMES 220
002		533018600	PLUG FITTING
002		537003000	PLUG M4 - LONG ELECTRODE
002		547002700	HIGH-VOLTAGE CABLE L=500
002		533010400	BICONE D.6
002		533045700	THERMOCOUPLE M9*1 500
002		533018500	FITTING FOR BICONE D.6 M10*1
002		536004900	NUT M22 FOR PIEZOELECTRIC IGNITION
002		537008500	PIEZOELECTRIC IGNITION M22 CW-60/65
002		536013600	COCK KNOB BR-62G/CW-61/2G
002		533039100	BICONE §6
002		533069000	BY PASS COCK §70 20S-21S
002		531018900	SAFETY TAP 21S-B PEL21S12070
002		533020200	PILOT JETS 0160 FOR LPG §30
002		533043200	NOZZLE §110 G30 (LPG) CH12X14
002		533030100	NOZZLE §95 CH12*14 G-FP
002		533020400	NOZZLE 0160 (NATURAL GAS) 51
002		533030200	NOZZLE §170 CH12*14 MH-FG L-FP/CW
002		533043100	NOZZLE §185 G25 CH12X14